

FRENCH FITNESS

OWNER'S MANUAL

FF-FSR90-V3

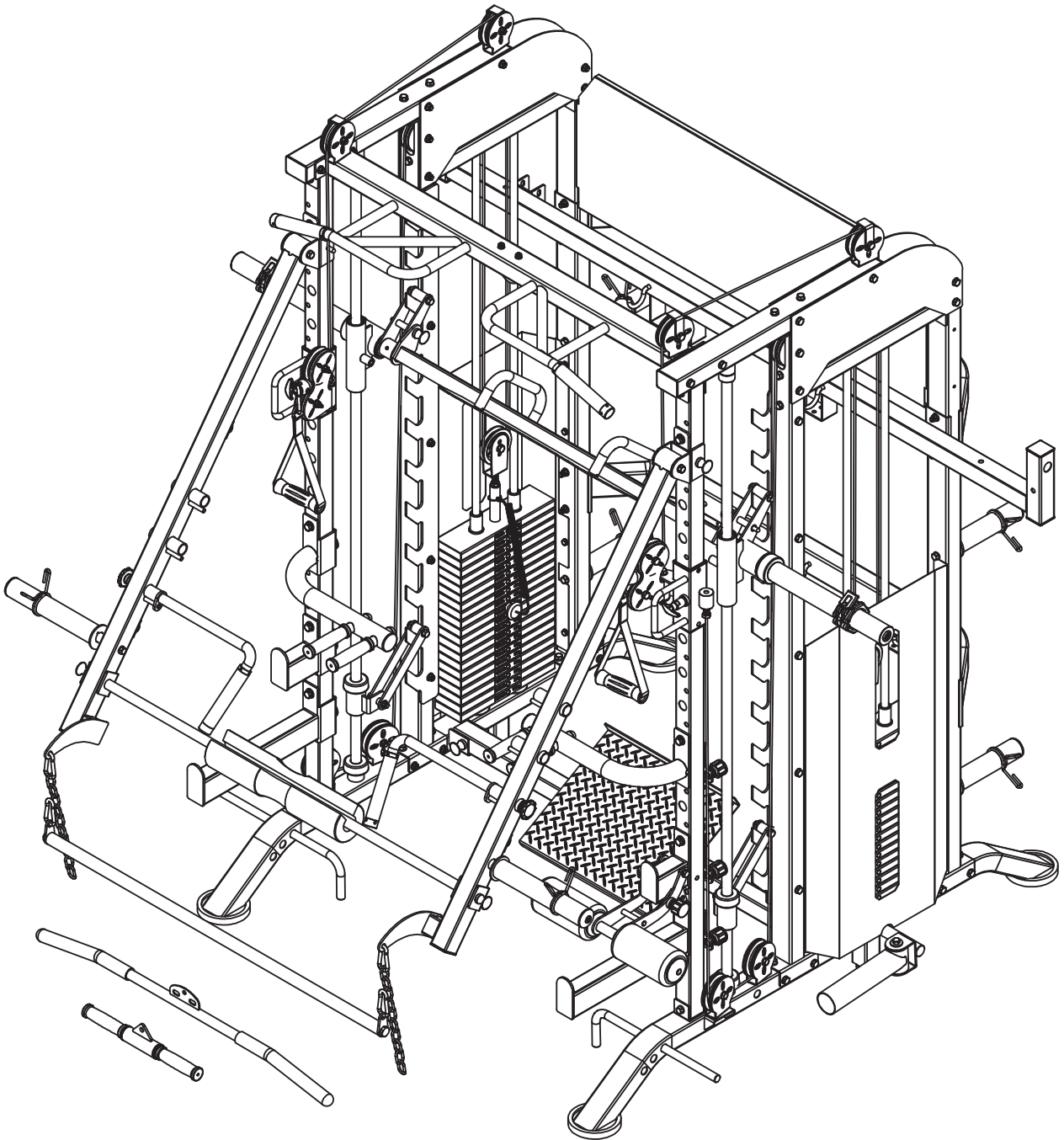

CAUTION!

Read all precautions and instructions in this manual before using this equipment.

20230319-V2.0

IMPORTANT SAFETY NOTICE

PRECAUTIONS

This exercise machine is built for optimum safety. However, certain precautions apply whenever you operate a piece of exercise equipment. Be sure to read the entire manual before you assemble or operate your machine. In particular, note the following safety precautions:

1. **Keep children and pets away from the machine at all times. DO NOT leave children unattended in the same room with the machine.**
2. Only one person at a time should use the machine.
3. If the user experiences dizziness, nausea, chest pain, or any other abnormal symptoms, STOP the workout at once. CONSULT A PHYSICIAN IMMEDIATELY.
4. Position the machine on a clear, leveled surface. DO NOT use the machine near water or outdoors.
5. Keep hands away from all moving parts.
6. Always wear appropriate workout clothing when exercising. DO NOT wear robes or other clothing that could become caught in the machine. Running or aerobic shoes are also required when using the machine.
7. Use the machine only for its intended use as described in this manual. DO NOT use attachments not recommended by the manufacturer.
8. Do not place any sharp object around the machine.
9. Disabled person should not use the machine without a qualified person or physician in attendance.
10. Before using the machine to exercise, always do stretching exercises to properly warm up.
11. Never operate the machine if the machine is not functioning properly.

WARNING: BEFORE BEGINNING ANY EXERCISE PROGRAM, CONSULT YOUR PHYSICIAN. THIS IS ESPECIALLY IMPORTANT FOR INDIVIDUALS OVER THE AGE OF 35 OR PERSONS WITH PRE-EXISTING HEALTH PROBLEMS. READ ALL INSTRUCTIONS BEFORE USING ANY FITNESS EQUIPMENT. WE ASSUME NO RESPONSIBILITY FOR PERSONAL INJURY OR PROPERTY DAMAGE SUSTAINED BY OR THROUGH THE USE OF THIS PRODUCT.

SAVE THESE INSTRUCTIONS.

Assembled Dimension: 1860mm×2230mm×2220mm

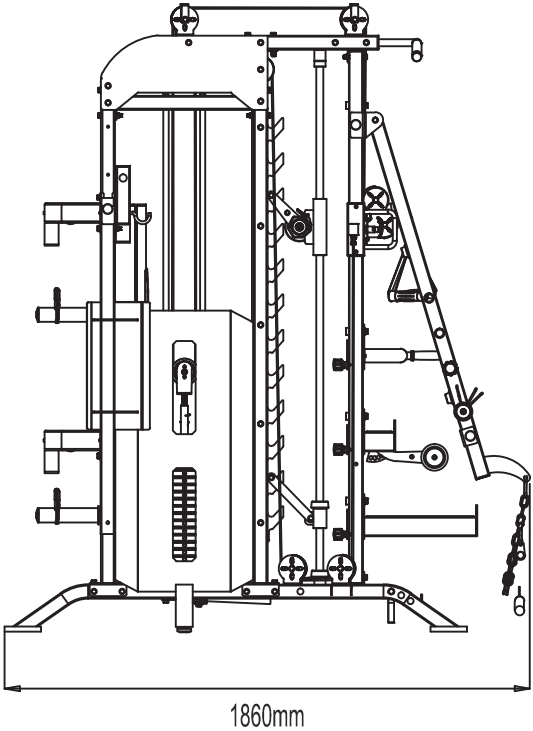
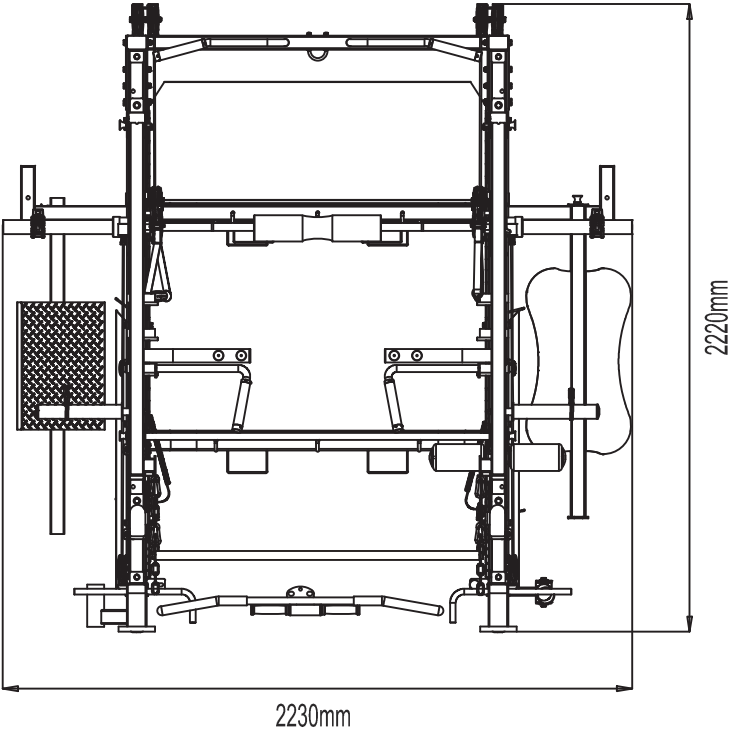

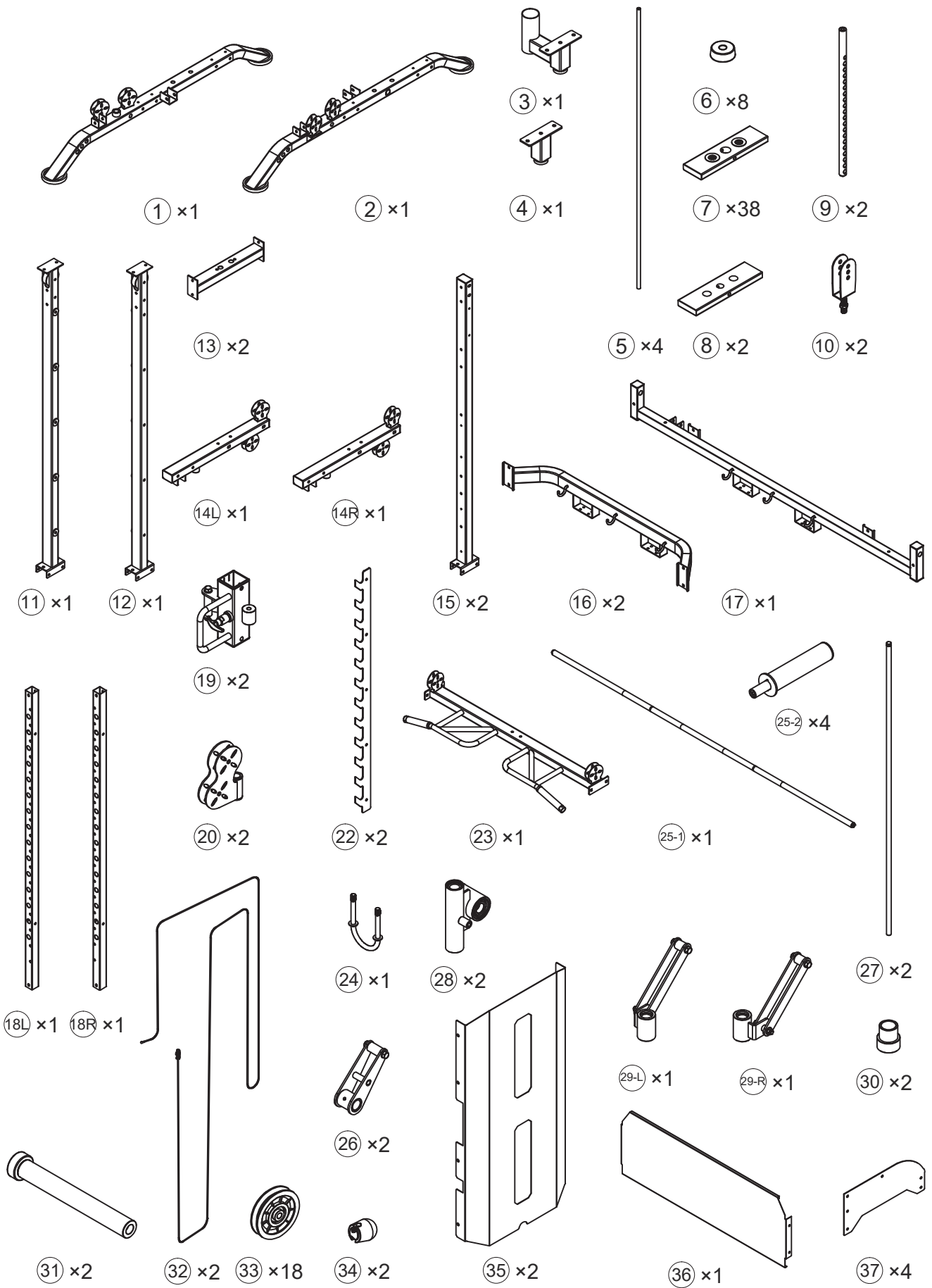

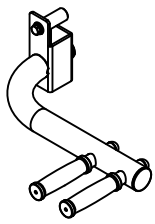

38 x1

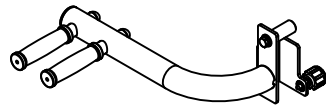

39 x1

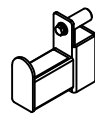

40 x1

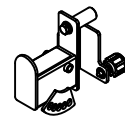

41 x1

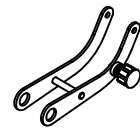

42 x1

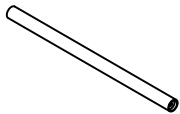

43 x1



44 x2

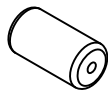

45 x2



46 x2

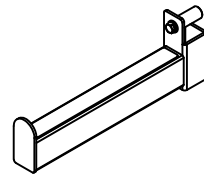

47 x1

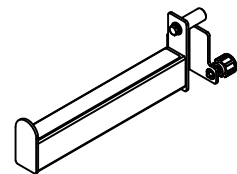

48 x1

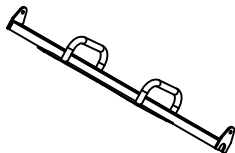

49 x1

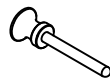

50 x8

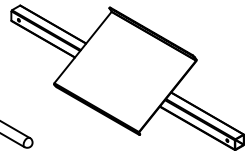

51 x1



52 x2

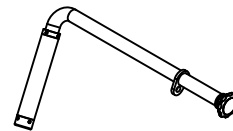

56 x2

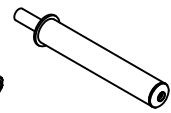

57 x2

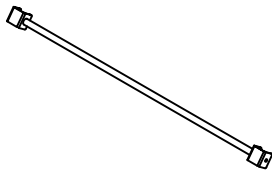

58 x1

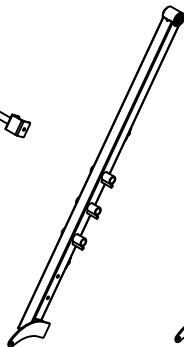

53 x1

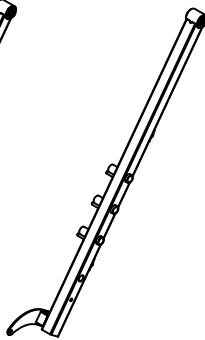

54 x1



59 x4

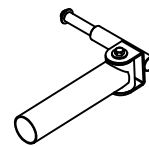

60 x1

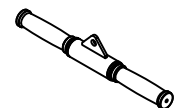

63 x1

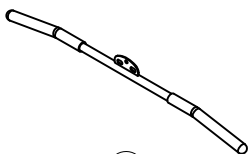

92 x1

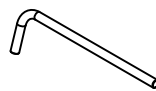

67 x2

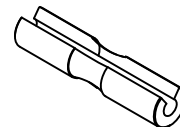

74 x1



83 x4

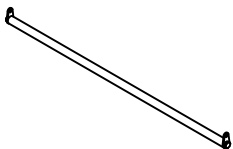

93 x1



89 x2



94 x4



96 x2



101 x2



102 x6



108 x2

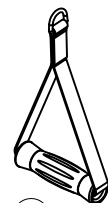

111 x2

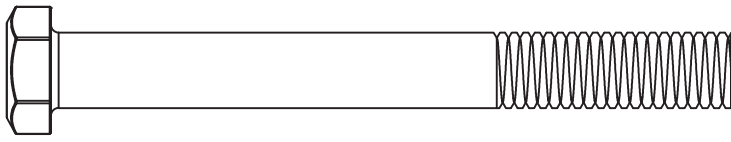

120 × 25

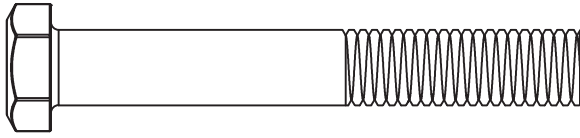

121 × 24

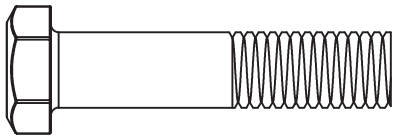

123 × 16

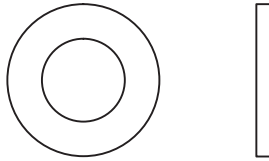

130 × 172

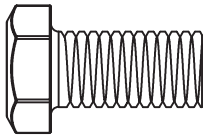

124 × 22

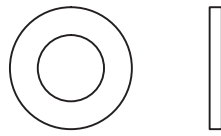

137 × 10

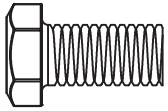

125 × 20

132 × 22

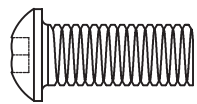

127 × 2



133 × 2

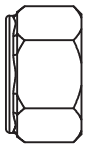

129 × 75

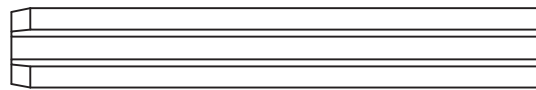

103 × 2

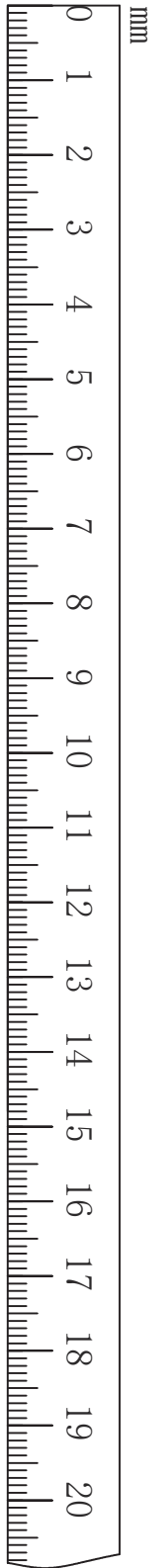
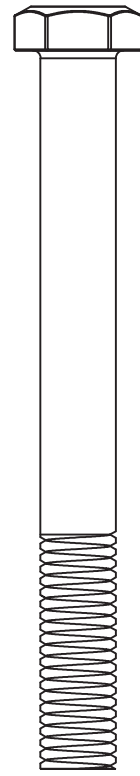

mm





12#×1



6#×1

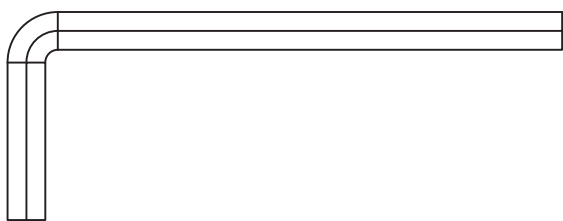

5#×1

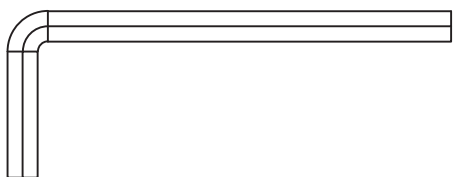

4#×1



2.5#×1

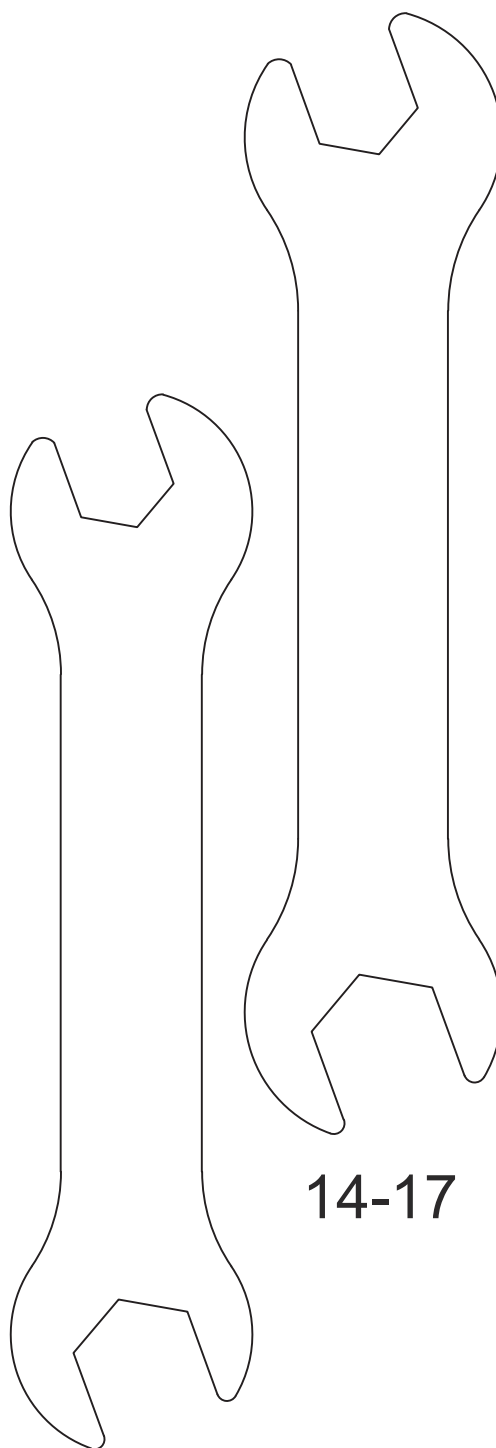

14-17

13-16

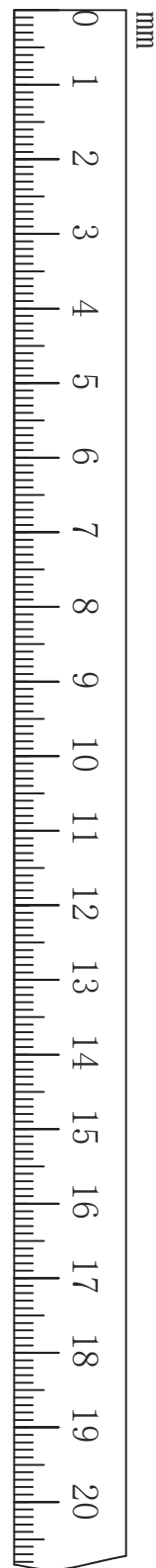

120  × 4 M10×90mm

129  × 12 M10





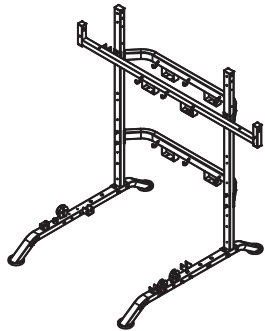
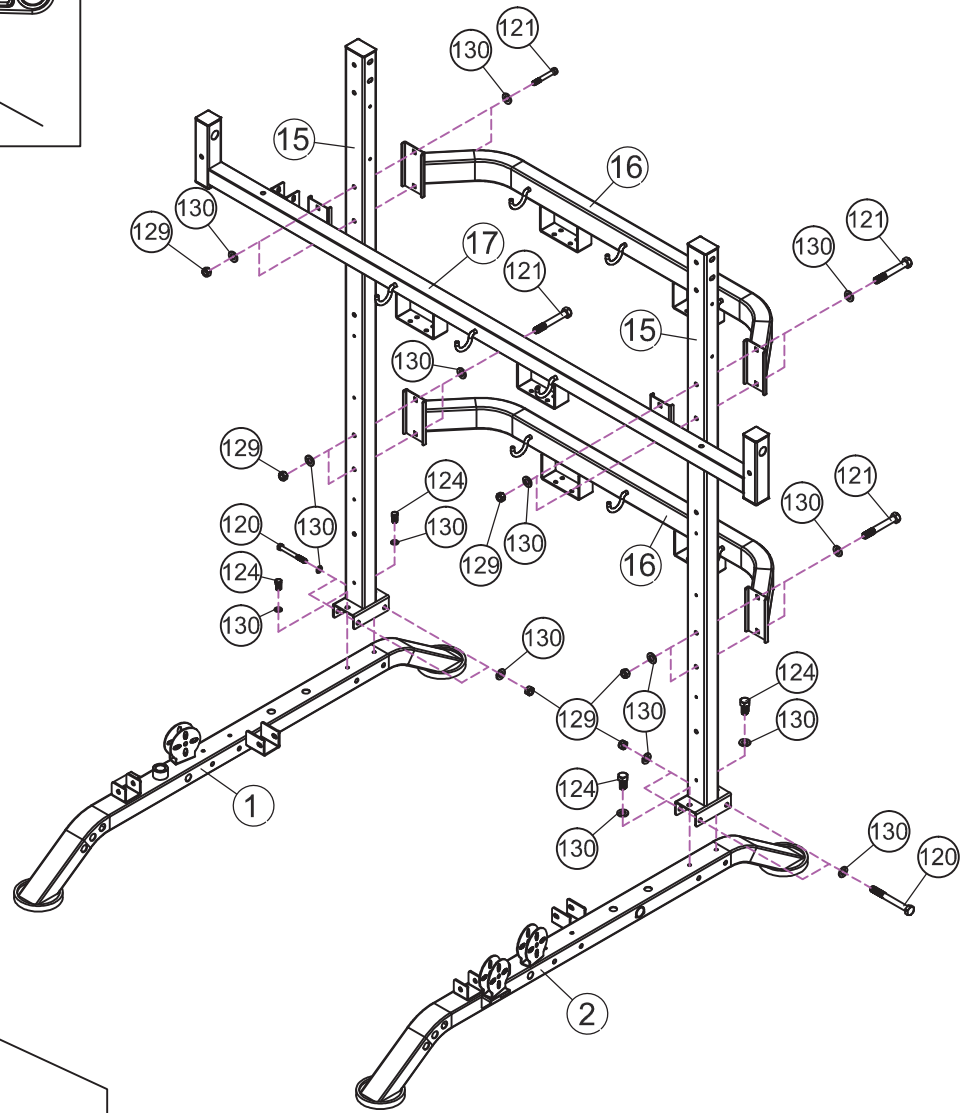
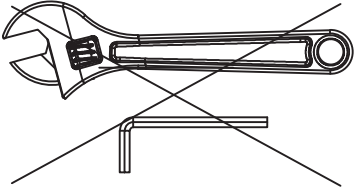

121  × 8 M10×70mm

130  × 28 Φ20×Φ10.5

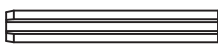
124  × 4 M10×20mm



1

- | | | | | | | | |
|----|---|-----|----------|----|--|------|-----------|
| ⑩③ |  | × 2 | M10×70 | ⑩④ |  | × 12 | M10×20mm |
| ⑩② |  | × 4 | M10×90mm | ⑩⑨ |  | × 12 | M10 |
| ⑩① |  | × 8 | M10×70mm | ⑩③ |  | × 36 | Φ20×Φ10.5 |

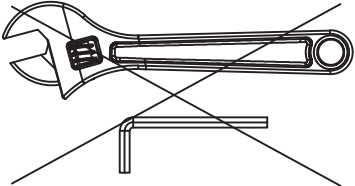





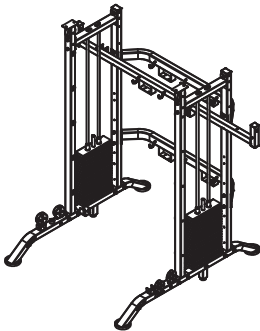
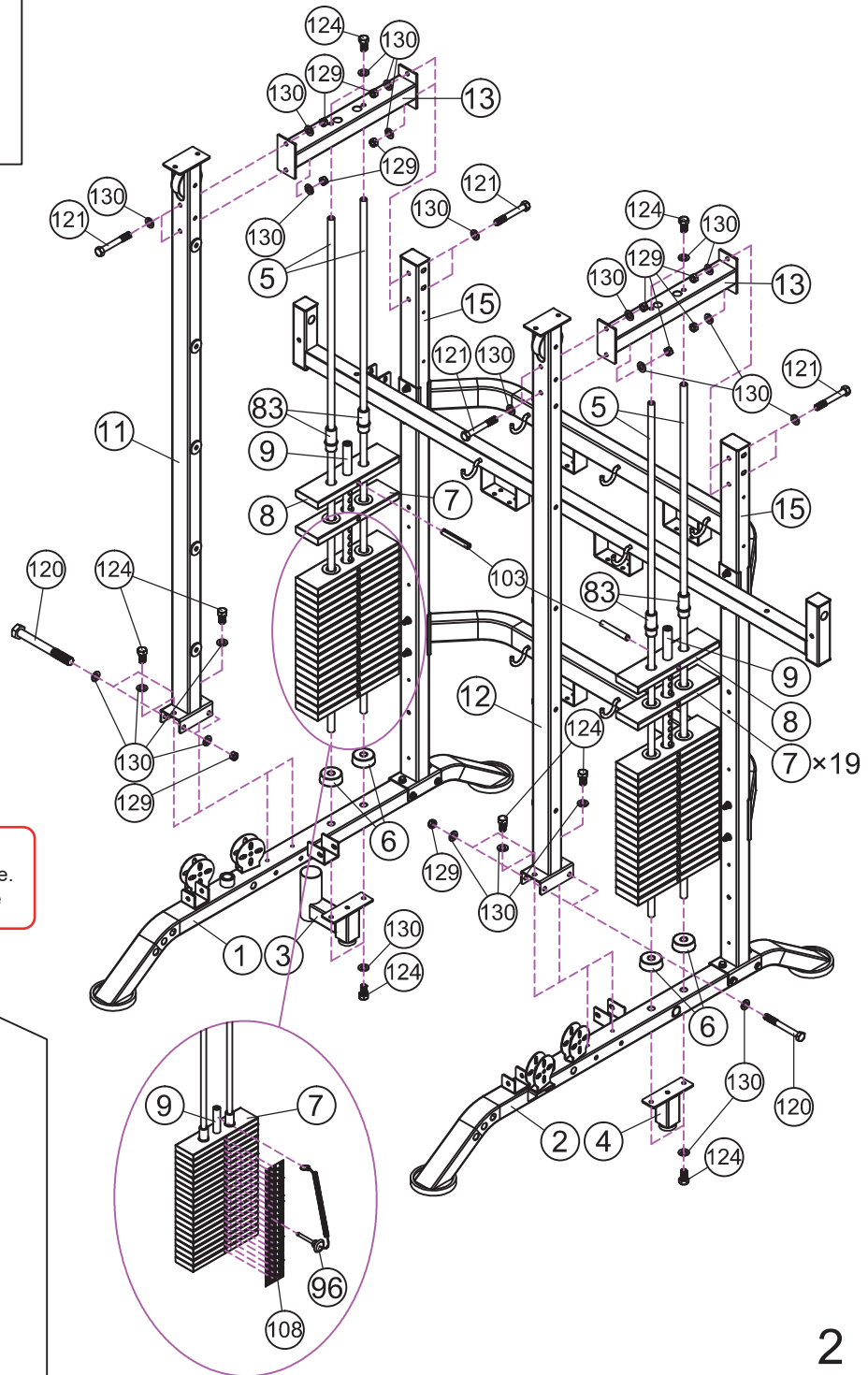

Install (4) total top plate bushings on the top of the top plate

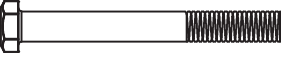
If you tighten every bolt firmly at first, it may result in the distortion of the finished product. To avoid this, tighten bolts lightly until the main frame is assembled and leveled then fasten the all bolts firmly.

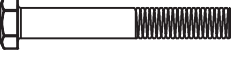
Parts 7: (40) Weight Plates - If you cannot locate, check under the crate. They are frequently packaged there

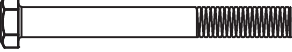

- | | | | | | | | |
|-------|---|------|----------|-------|--|------|-----------|
| (120) |  | × 4 | M10×90mm | (130) |  | × 44 | Φ20×Φ10.5 |
| (121) |  | × 8 | M10×70mm | (132) |  | × 2 | Φ16×Φ8.4 |
| (129) |  | × 22 | M10 | (133) |  | × 2 | M8 |
| (137) |  | × 10 | M10×95mm | | | | |

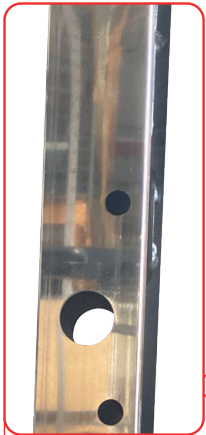
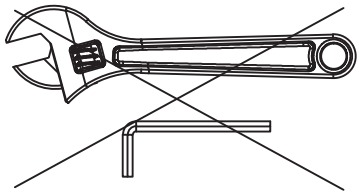

Single Small Hole, Followed by a Large Hole, then another single Hole, at Top of Cable Columns facing out. Also, make sure double holes are on the outer (not inner) part of the machine - so for the right column, on the right side... and for the left column, on the left side.

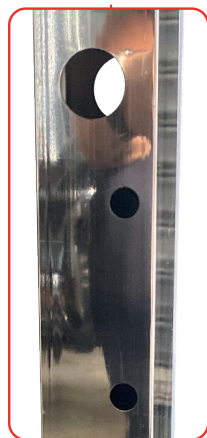
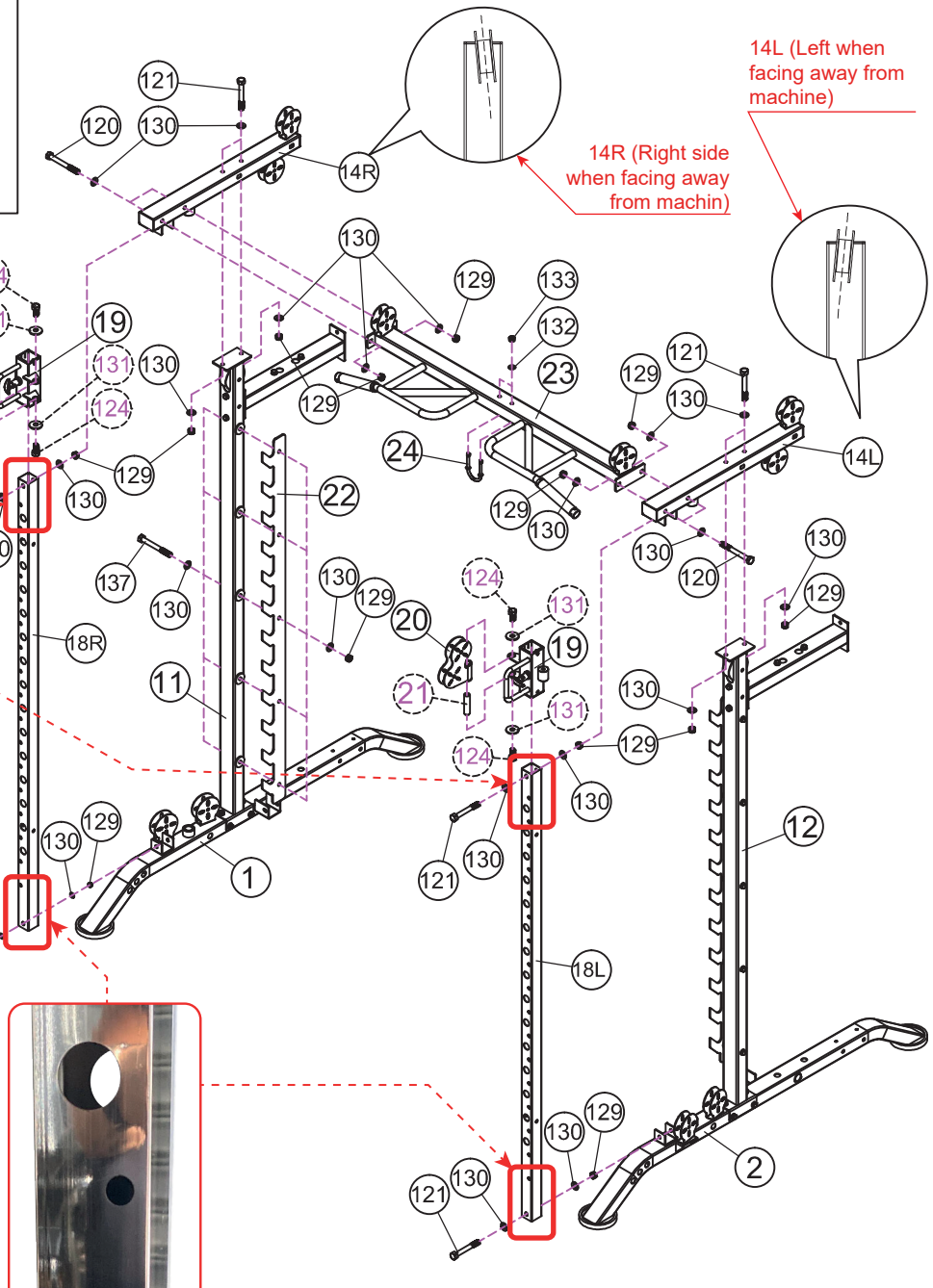
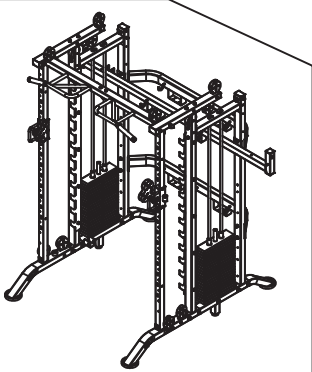

Double Small Hole Pattern at Bottom of Cable Columns Facing Out. Also, make sure double holes are on the outer (not inner) part of the machine - so for the right column, on the right side... and for the left column, on the left side.

3

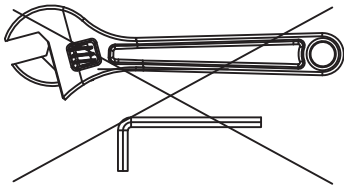

Please note that the parts in image A have been pre-assembled. Before installation, the parts in image A need to be disassembled as shown in image B, and then proceed to the next step of installation.

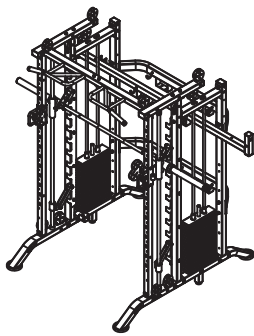
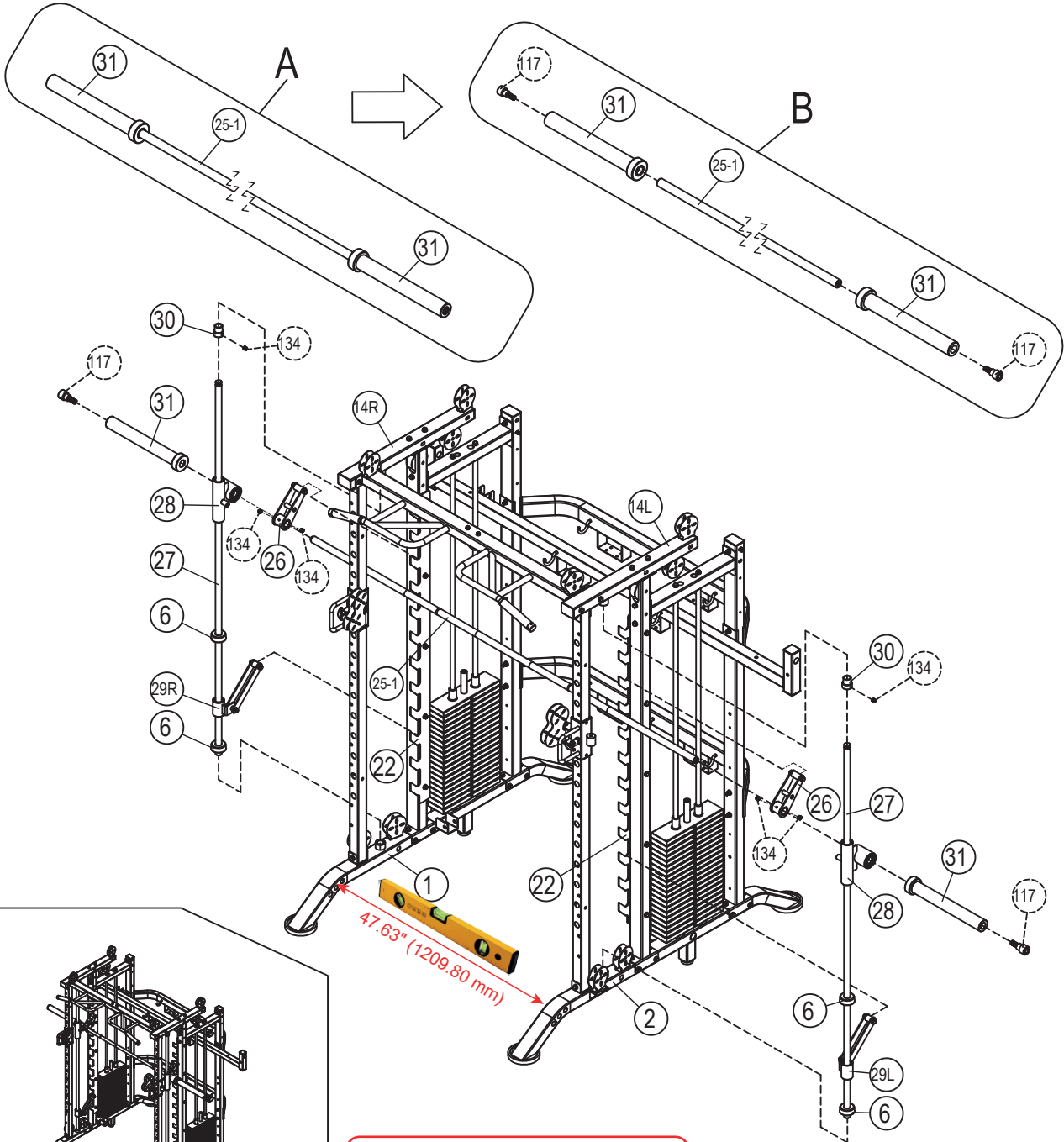

If you tighten every bolt firmly at first, it may result in the distortion of the finished product. To avoid this, tighten bolts lightly until the main frame is assembled and leveled then fasten the all bolts firmly.

123  × 16 M10×45mm

130  | × 32 Φ20×Φ10.5

129  × 16 M10

108 × 2

11LBS	○	5kg
22LBS	○	10kg
33LBS	○	15kg
44LBS	○	20kg
55LBS	○	25kg
66LBS	○	30kg
77LBS	○	35kg
88LBS	○	40kg
99LBS	○	45kg
110LBS	○	50kg
121LBS	○	55kg
132LBS	○	60kg
143LBS	○	65kg
154LBS	○	70kg
165LBS	○	75kg
176LBS	○	80kg
187LBS	○	85kg
198LBS	○	90kg
210LBS	○	95kg
220LBS	○	100kg

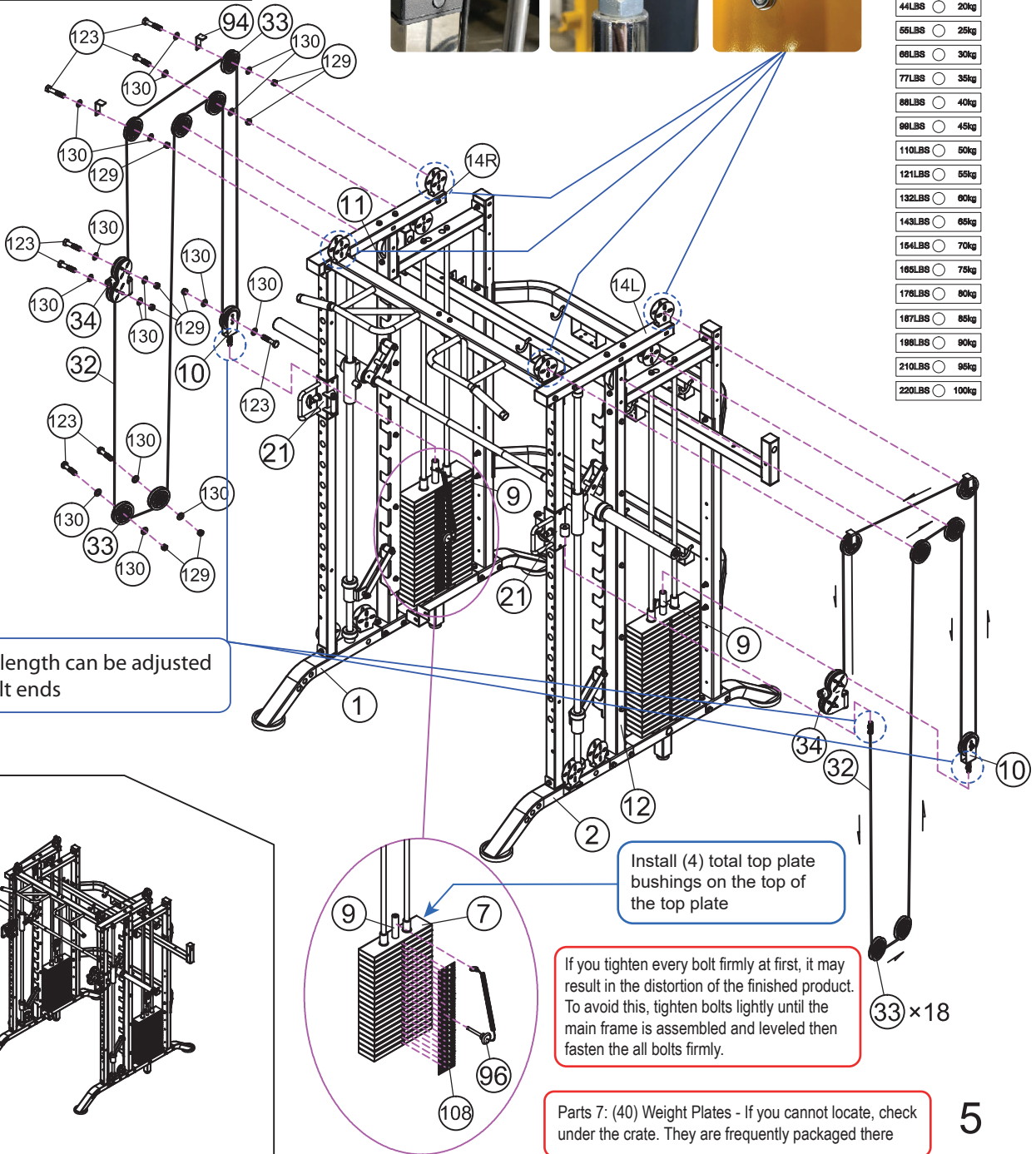
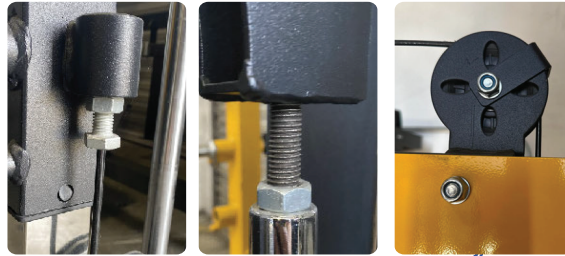
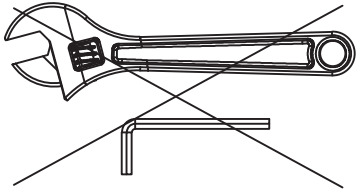

Cable length can be adjusted via bolt ends







Install (4) total top plate bushings on the top of the top plate

If you tighten every bolt firmly at first, it may result in the distortion of the finished product. To avoid this, tighten bolts lightly until the main frame is assembled and leveled then fasten the all bolts firmly.

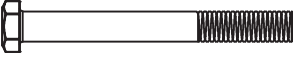
Parts 7: (40) Weight Plates - If you cannot locate, check under the crate. They are frequently packaged there

33 × 18

5

- | | | | | | |
|-------|---|---|----------|--|----------------|
| (120) |  | × 12 M10×90mm | (130) |  | × 24 Φ20×Φ10.5 |
| (125) |  | × 20 M8×16mm | (132) |  | × 20 Φ16×Φ8.4 |
| (129) |  |  | × 12 M10 | | |

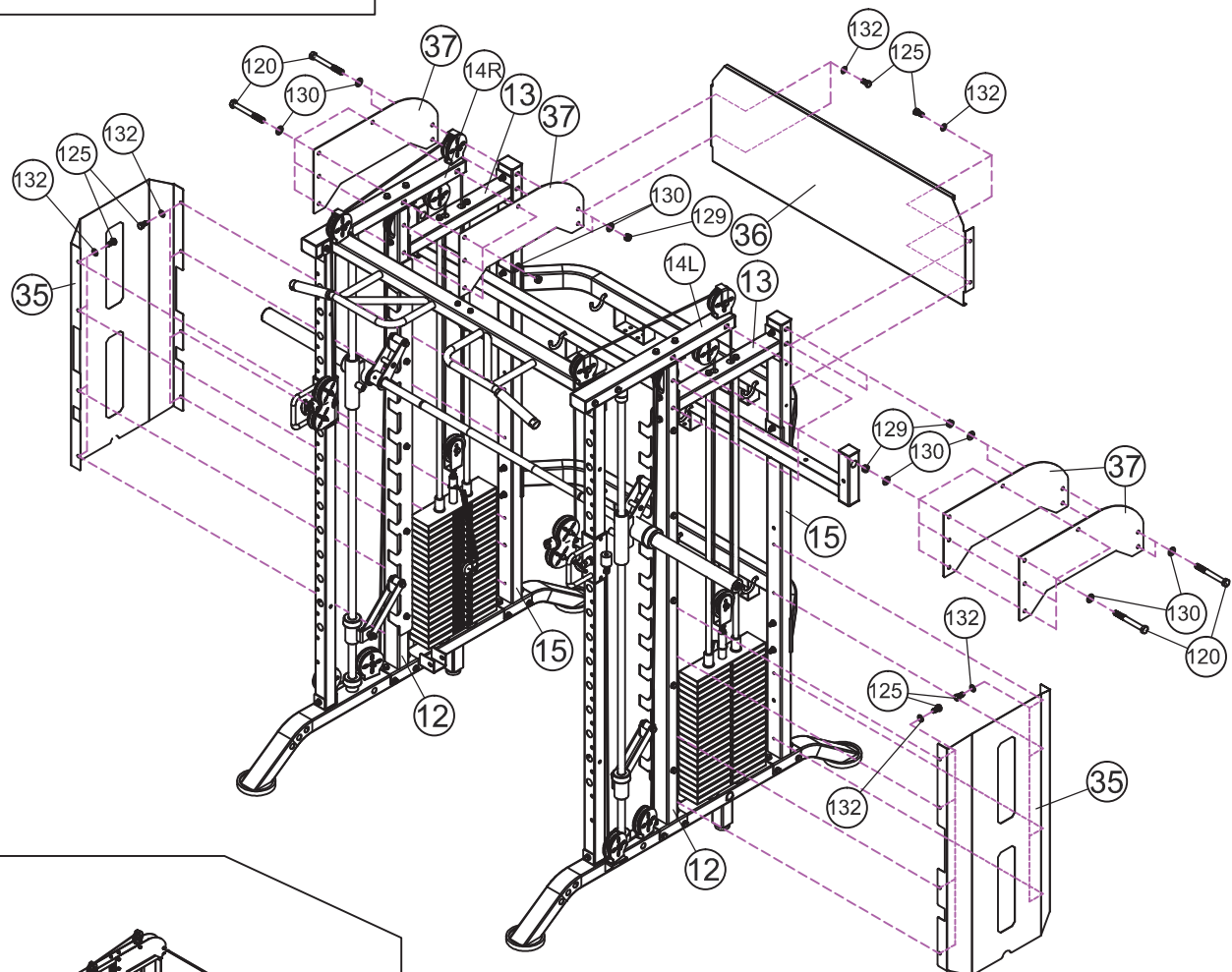
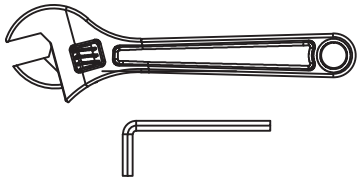

(120)  × 1 M10×90mm

(129)  × 1 M10

(127)  × 2 M8×20mm

(130)  | × 2 Φ20×Φ10.5

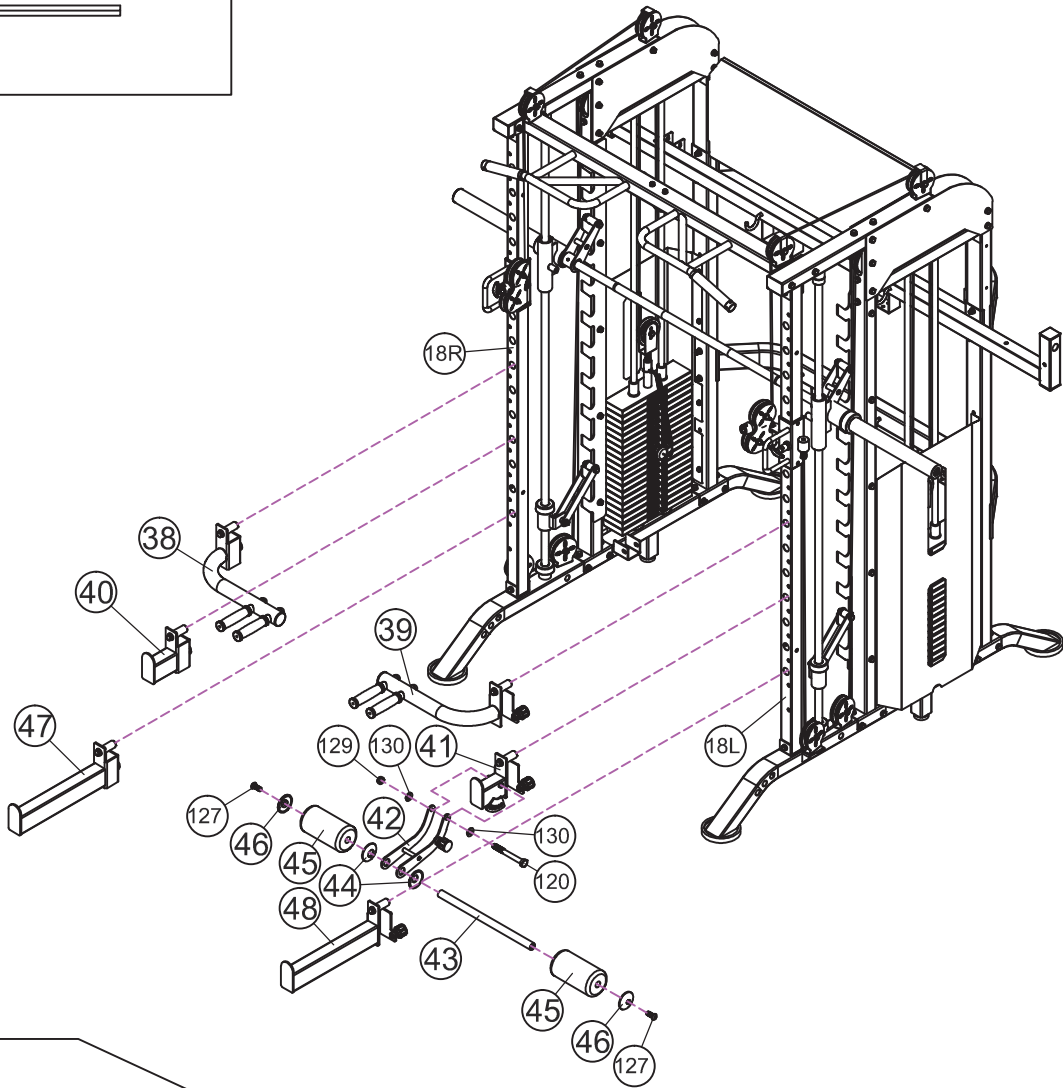
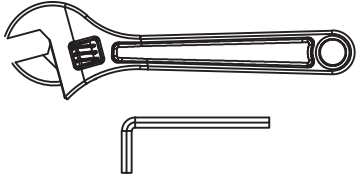

124



× 4 M10×20mm

130



× 4 Φ20×Φ10.5

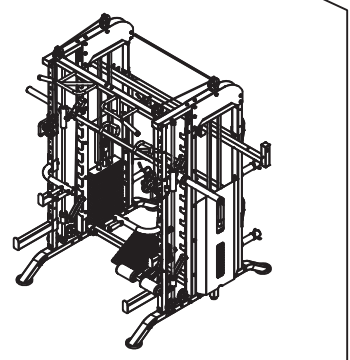
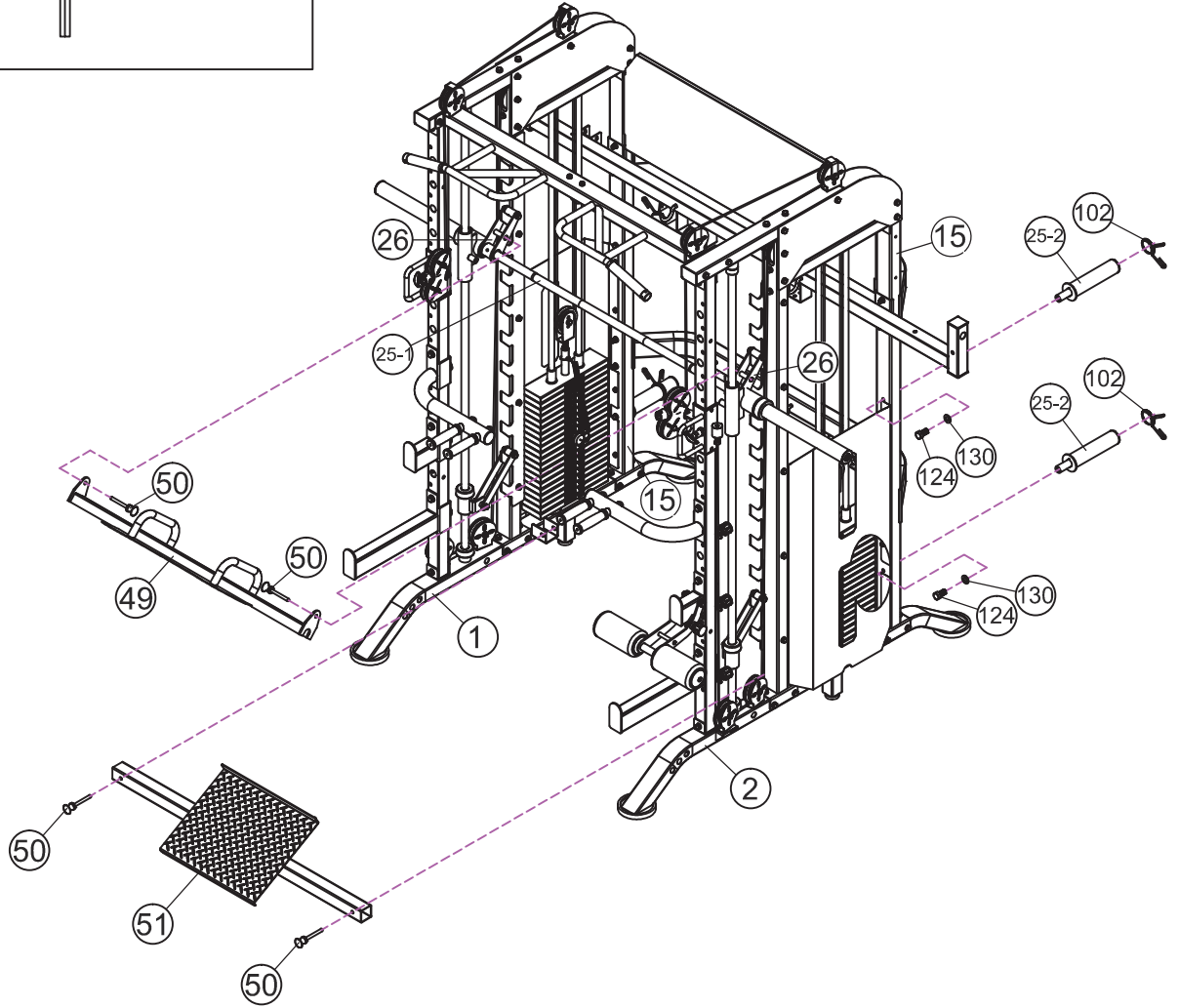
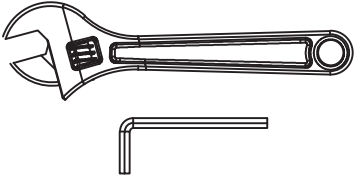

124



× 2 M10×20mm

130



× 2 Φ20×Φ10.5

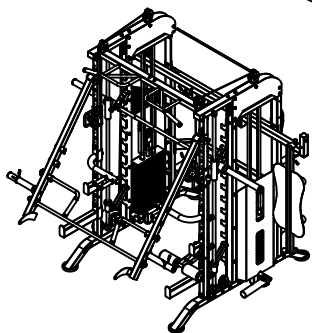
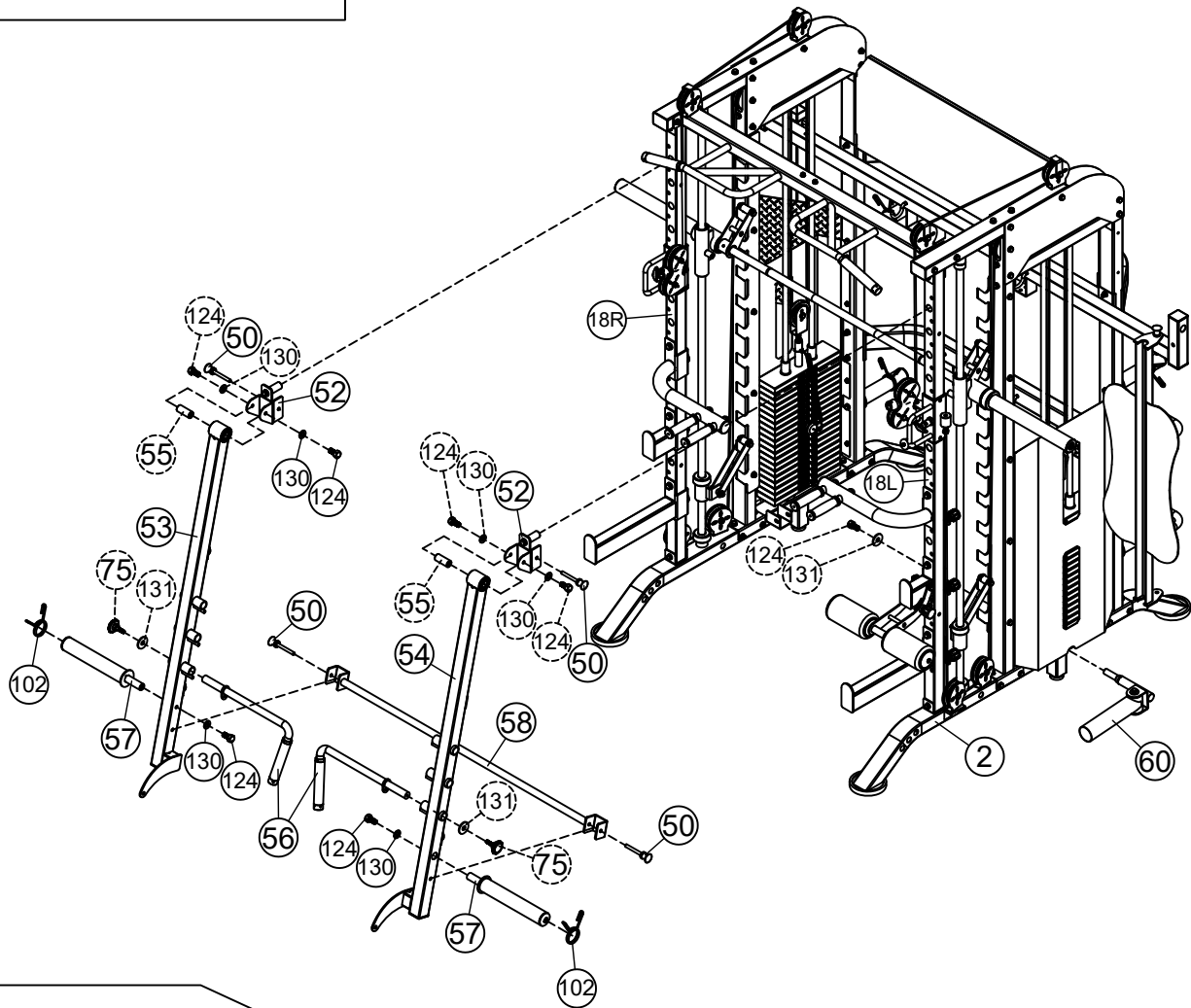
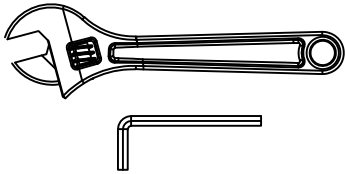

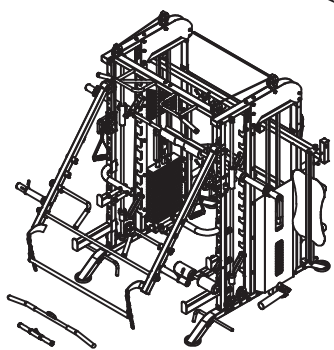
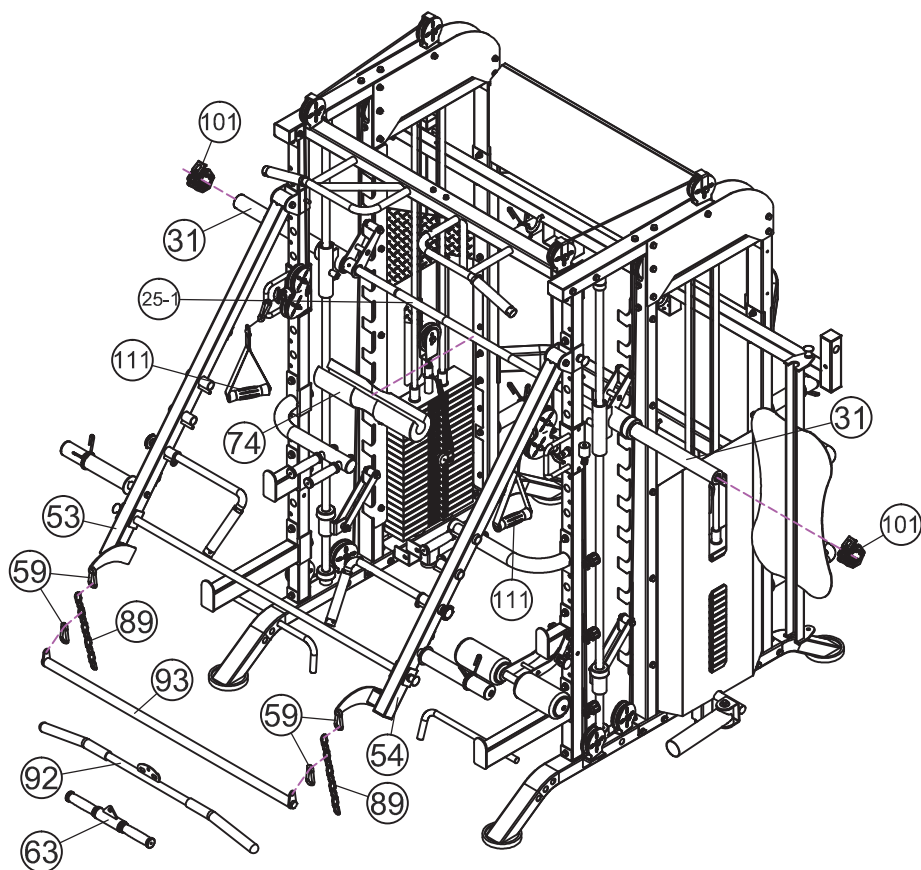

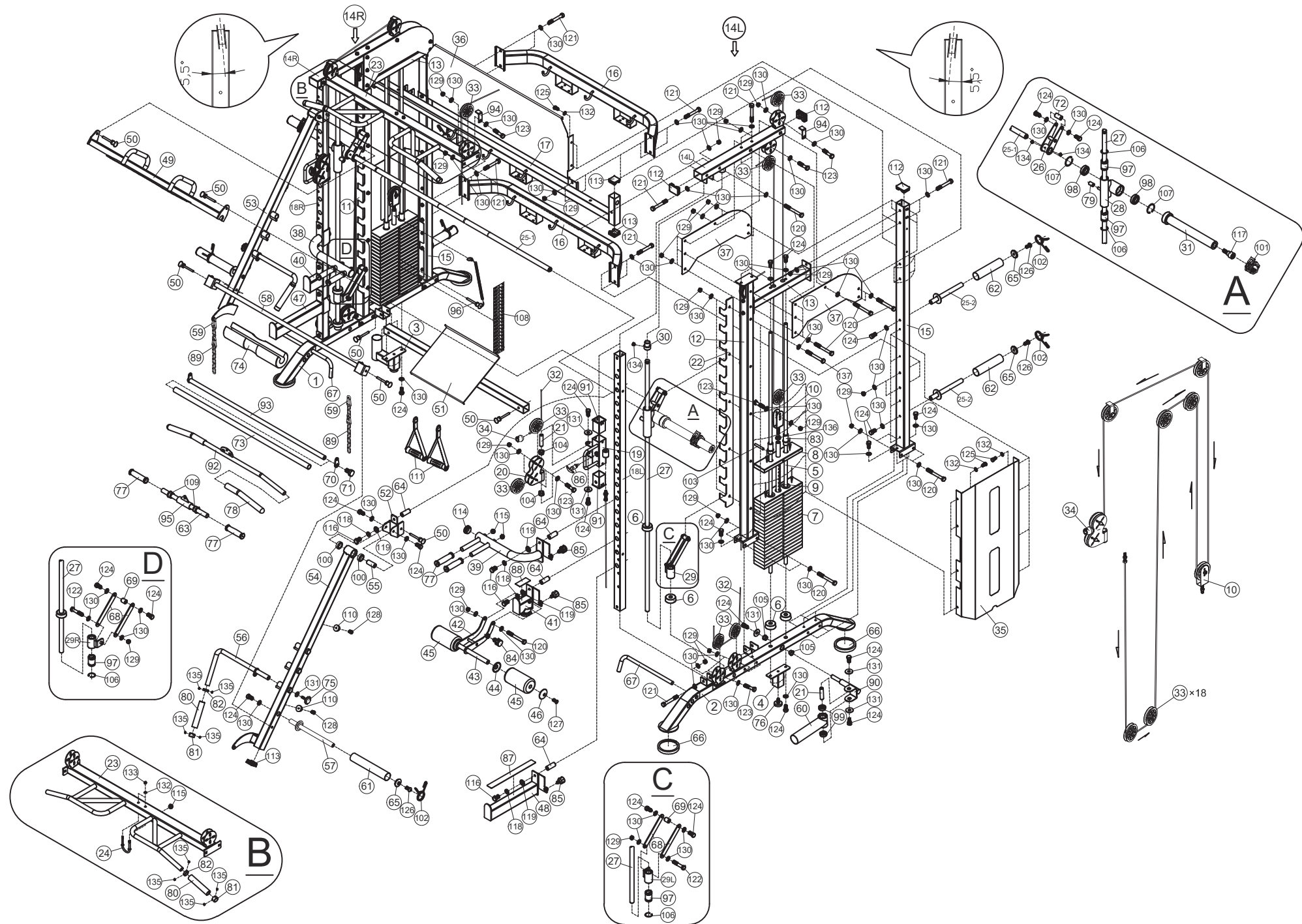

PARTS LIST

KEY NO.	PART DESCRIPTION	SPEC	QTY
1	Bottom bending tube(left welding)		1
2	Bottom bending tube(right welding)		1
3	Adjustable foot tube right welding		1
4	Adjustable foot tube left welding		1
5	Guiding rod weldment	φ19×1775	4
6	Rubber Stopper	φ62×φ24.5×25	8
7	Weight Plate		38
8	Top Weight Plate	325×90×24	2
9	Lifting rod	φ25×620 (19+1)	2
10	Pulley Case		2
11	Middle riser (right welding)		1
12	Middle riser (left welding)		1
13	Counterweight upper supporting tube		2
14 L	Upper supportign tube(left welding)		1
14 R	Upper supportign tube(right welding)		1
15	Rear riser weldment		2
16	Back supporting tube weldment		2
17	Hanging tube weldment		1
18 L	Stainless steel left adjustment tube	□50×1880	1
18 R	Stainless steel right adjustment tube	□50×1880	1
19	Adjusting sleeve tube weldment		2
20	Pulley piece weldment		2
21	Rotating Shaft	φ20×80×M10	3
22	Hook plate (chrome plated)	1530×110×5	2
23	Upper cross beam tube weldment		1
24	U-shaped hanging bolt weldment		1
25-1	Olympic Bar	φ32×M12×2198	1
25-2	Barbell sleeve tube weldment		4
26	Olympic rod hook weldment		2
27	Bearing steel	φ25×1850	2
28	Linear bearing sleeve weldment		2
29 R	Safety hook Bracket R		1
29 L	Safety hook Bracket L		1

PARTS LIST

KEY NO.	PART DESCRIPTION	SPEC	QTY
30	And Sliding Rod Fixing Sleeve	$\phi 40 \times \phi 25.5 \times 45$	2
31	Olympic barbell sleeve	$\phi 71 \times \phi 50 \times 415$	2
32	Double Pull Cable	$\phi 5 \times 7560\text{mm}$	2
33	Pulley	$\phi 96$	18
34	Ball End		2
35	Shield	$995 \times 490 \times 83 \times 1.2$	2
36	Sign board plate	$1210 \times 420 \times 250 \times 1.2$	1
37	Small guard plate	$590 \times 263 \times 3$	4
38	Parallel bar tube left weldment		1
39	Parallel bar tube right weldment		1
40	Olympic rod training rack tube 2 weldment		1
41	Olympic rod training rack tube 1 weldment		1
42	Foam support weldment		1
43	Foam tube weldment		1
44	FOAM Linner Baffle	$\phi 64 \times \phi 25.5 \times 10$	2
45	Foam Roll	$\phi 95 \times \phi 22 \times 180$	2
46	FOAM End Cover	$\phi 64 \times \phi 14 \times 12$	2
47	Olympic rod protection frame tube left weldment		1
48	Olympic rod protection frame tube right weldment		1
49	Inverse pedal weldment		1
50	spring pins		8
51	Foot pedal weldment		1
52	Cantilever connecting block weldment		2
53	Cantilever right weldment		1
54	Cantilever left weldment		1
55	Rotating Shaft	$\phi 25 \times M10 \times 61$	2
56	Cantilever handle weldment (chrome-plated)		2
57	Cantilever barbell sleeve tube weldment		2
58	Counterweight upper supporting tube		1
59	Hook	$\phi 8$	4
60	Barbell rod connecting tube weldment		1
61	Long Spacer	$\phi 50 \times 2 \times 295$	2
62	Short Spacer	$\phi 50 \times 2 \times 210$	4

PARTS LIST

KEY NO.	PART DESCRIPTION	SPEC	QTY
63	Handle thbe	$\phi 25 \times 1.5 \times 380$	1
64	Hanging post	$\phi 25 \times M12 \times 60$	8
65	Tube End Cap	$\phi 50 \times \phi 18 \times 11$	6
66	Floor End Cap	$\phi 129 \times 18$	4
67	Elastic rope hanging hook (chrome-plated)	$\phi 20 \times 430 \times 120$	2
68	Termination hook plate	230×30×5	4
69	Axis	$\phi 25 \times 30 \times M10$	2
70	Connecting rod commecting plates	$\phi 32 \times \phi 22 \times 67 \times 5$	2
71	Screws	$\phi 25 \times \phi 15 \times 34$	2
72	Rotating Shaft	$\phi 25 \times M10 \times 45$	2
73	Handle Grip	$\phi 24 \times 1145$	1
74	Foam Carry on one 's shoulder	$\phi 100 \times \phi 42 \times 450$	1
75	Quincunx handle	M10×35	2
76	Foundation bolt	M12×30	2
77	Handle Grip	$\phi 34 \times \phi 25 \times 132$	6
78	Handle Grip	$\phi 32 \times 320$	2
79	End Cap	$\phi 20 \times \phi 12 \times 30$	2
80	Dips Handle	$\phi 23 \times 160$	4
81	Cover Cap	$\phi 33 \times \phi 26 \times 18.8$	4
82	Retaining ring	$\phi 33 \times \phi 26 \times 10$	4
83	Bushing	$\phi 36 \times \phi 30 \times \phi 20 \times 74$	4
84	Moving Lock Pin	M18× $\phi 10$	1
85	Moving Lock Pin	M16× $\phi 8$	6
86	Moving Lock Pin	M20× $\phi 10$	2
87	Rack Liner	380×40×2	2
88	Rack Liner	90×40×2	2
89	10-Joint Chain	$\phi 5 \times 10$	2
90	Adaptable connecting shaft weldment		1
91	Slide Guide	$\square 60 \times 2 \times \square 50 \times 80$	4
92	Pulling bar weldment		1
93	Connecting rod weldment		1
94	Steel rope cover plate	66×35×25×4	4
95	Dropbar sleeve tube welding		1

PARTS LIST

KEY NO.	PART DESCRIPTION	SPEC	QTY
96	Weight Selector Pin	φ10×90	2
97	Linear Motion Bearing	φ40×φ25×59	6
98	Bearing	62-28	4
99	Bearing	6004	2
100	Bearing	6005	4
101	Buckle	φ50	2
102	Spring Clip	φ49	6
103	Top plate pin	M10×70	2
104	Bushing	φ32×φ20×19	4
105	Bushing	φ30×φ26×φ20×16	2
106	Hole circlip	d0=40	6
107	Hole circlip	d0=58	4
108	Weight Plate Sticker 130kg	5-130KG	2
109	Bushing	φ38×φ34×φ27×26	2
110	Rubber Stopper	φ38×φ7×15	4
111	Nylon Strap Iso-Handle	L=245mm	2
112	Rectangular End Cap	□70×□50	6
113	Rectangular End Cap	□50	6
114	End Cap	φ48	2
115	End Cap	φ25	6
116	HEX Bolt	M12×20	8
117	Hexagon socket button head screws	M14×35	2
118	Washer	12	8
119	Washer	12	8
120	HEX Bolt	M10×90	25
121	HEX Bolt	M10×70	24
122	HEX Bolt	M10×55	2
123	HEX Bolt	M10×45	16
124	HEX Bolt	M10×20	41
125	HEX Bolt	M8×16	20
126	Allen Bolt	M10×20	6
127	Allen Bolt	M8×20	2
128	Allen Bolt	M8×16	4

PARTS LIST

KEY NO.	PART DESCRIPTION	SPEC	QTY
129	Nut	M10	77
130	Washer	10	188
131	Washer	φ30×φ10.5×2.5	9
132	Washer	8	22
133	Nut	M8	2
134	Set screw	M8×10	6
135	Set screw	M5×4	16
136	Hex nuts	M12	2
137	HEX Bolt	M10×95	10
	Allen Wrench	12#	1
	Allen Wrench	6#	1
	Allen Wrench	5#	1
	Allen Wrench	4#	1
	Allen Wrench	2.5#	1
	Fork Wrench	13-16	1
	Fork Wrench	14-17	1